

Pro-face

by Schneider Electric

SCIENCE
GATE
Your Automation Partner



SCIGATE AUTOMATION (S) PTE LTD

No.1 Bukit Batok Street 22 #01-01 Singapore 659592

Tel: (65) 6561 0488

Fax: (65) 6562 0588

Email: sales@scigate.com.sg

Web: www.scigate.com.sg

Business Hours: Monday - Friday 8.30am - 6.15pm

FP5000 Series Installation Guide



Please read the “Warning/Caution Information” on the attached sheet before using the product.

Safety Information

Important Information	5
-----------------------------	---

Model Numbers

Model Numbers	7
Global Code	7

Overview

Package Contents	8
About the Manual	8

Parts Identification

FP-5600TPD/5700TPD	9
LED Indications	10

Specifications

Electrical Specifications	11
Environmental Specifications	12

Interface

DVI-D Input Interface	13
-----------------------------	----

Installation

System Structure	15
Installation Requirements	16
Panel Cut Dimensions	19
Installation Procedure	20
Removal Procedure	24

Wiring

Wiring	27
--------------	----

USB Clamp

USB Clamp	34
-----------------	----

Front USB Cover

Front USB Cover.....37

Front USB Port

Front USB Port.....40

Launcher

Launcher43

Standards

Standards.....49

Important Information

Notice

Read these instructions carefully, and look at the equipment to become familiar with the device before trying to install, operate, or maintain it. The following special messages may appear throughout this documentation or on the equipment to warn of potential hazards or to call attention to information that clarifies or simplifies a procedure.



The addition of this symbol to a "Danger" or "Warning" safety label indicates that an electrical hazard exists which will result in personal injury if the instructions are not followed.



This is the safety alert symbol. It is used to alert you to potential personal injury hazards. Obey all safety messages that follow this symbol to avoid possible injury or death.

DANGER

DANGER indicates a hazardous situation which, if not avoided, **will result in** death or serious injury.

WARNING

WARNING indicates a hazardous situation which, if not avoided, **could result in** death or serious injury.

CAUTION

CAUTION indicates a hazardous situation which, if not avoided, **could result in** minor or moderate injury.

NOTICE

NOTICE is used to address practices not related to physical injury.

PLEASE NOTE

Electrical equipment should be installed, operated, serviced, and maintained only by qualified personnel. No responsibility is assumed by Pro-face for any consequences arising out of the use of this material.

A qualified person is one who has skills and knowledge related to the construction and operation of electrical equipment and its installation, and has received safety training to recognize and avoid the hazards involved.

If the equipment is used in a manner not specified by the manufacturer, the protection provided by the equipment may be impaired.

Model Numbers

Series	Display size	Model name	Model number
FP5000 Series	12.1-inch	FP-5600TPD	PFXFP5600TPD
	15-inch	FP-5700TPD	PFXFP5700TPD

Global Code

A global code is assigned to every Pro-face product as a universal model number.

For more information on product models and their matching global codes, please refer to the following URL.

<http://www.pro-face.com/trans/en/manual/1003.html>

Package Contents

The following items are included in the package. Before using this product, please confirm that all items listed here are present:

1

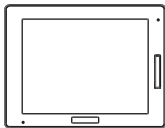

2



3

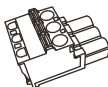

4

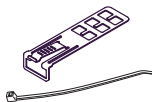

5

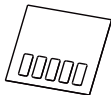

- 1 FP5000 Series: 1
- 2 Installation gasket: 1 (attached to this product)
- 3 DC power supply connector (right angle): 1
- 4 USB clamp (Type B): 1 set (1 clip and 1 tie)
- 5 USB masking sticker (mini-B)*1: 1
- 6 FP5000 Series Installation Guide (this guide): 1
- 7 Warning/Caution Information: 1

*1 See Parts Identification (see page 9).

This product has been carefully packed, with special attention to quality. However, should you find anything damaged or missing, please contact your local distributor immediately.

About the Manual

This manual describes the wiring and installation procedures for this product. For more detailed information, refer to the FP5000 Series User Manual. You can download the manual from our website at:
<http://www.pro-face.com/trans/en/manual/1001.html>.

FP-5600TPD/5700TPD

NOTE: The figures below show FP-5600TPD.

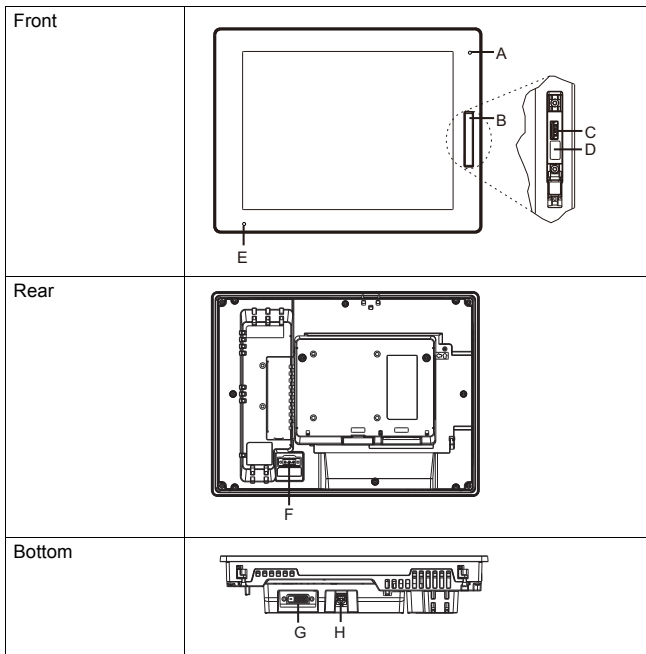

- A: Brightness sensor
- B: Front USB cover
- C: USB (Type A) interface
- D: USB masking sticker (mini-B)^{*1}
- E: Status LED (see page 10)
- F: Power connector
- G: DVI-D input interface
- H: USB (Type B) interface

^{*1} You cannot use the USB (mini-B) interface. Affix the provided USB masking sticker.

LED Indications

Status LED

Color	Indicator	Description
Green	ON	In operation
	LED fade	Backlight is OFF (Standby Mode), or no video input signal
Green/ Orange	Alternating	Launcher is being configured (see page 43)
Orange	Flashing	Software is starting up
Red	ON	Power is turned ON
Orange/ Red/ Green	Alternating	Display unit error* ¹
–	OFF	Power is turned OFF

*1 The product may be malfunctioning. Please contact your local distributor.

NOTE: If the screen does not display and the status LED is not in the LED fade state, this indicates the backlight is burned out. When the screen does not display, always check the LED status and do not perform touch operations.

Electrical Specifications

Specification		FP-5600TPD	FP-5700TPD	
Power supply	Rated input voltage	12...24 Vdc		
	Input voltage limits	10.8...28.8 Vdc		
	Voltage drop	12 Vdc: 2.5 ms or less 24 Vdc: 10 ms or less		
	Power consumption (primary power supply including power loss)	Backlight ON: 100% (Power is supplied to external devices)	17 W or less	21 W or less
		Backlight ON: 100% (Power is not supplied to external devices)	14 W or less	18 W or less
		Backlight adjusted: 20% (Power is not supplied to external devices)	9 W or less	11 W or less
		Backlight OFF (Power is not supplied to external devices)	7 W or less	8 W or less
In-rush current	30 A or less			
Voltage endurance	1,000 Vac, 20 mA for 1 minute (between charging and FG terminals)			
Insulation resistance	500 Vdc, 10 M Ω or more (between charging and FG terminals)			

Environmental Specifications

Physical environment	Surrounding air temperature	0...60 °C (32...140 °F)
	Storage temperature	-20...60 °C (-4...140 °F)
	Surrounding air and storage humidity	10...90% RH (non-condensing, wet bulb temperature 39 °C [102.2 °F] or less)
	Dust	0.1 mg/m ³ (10 ⁻⁷ oz/ft ³) or less (non-conductive levels)
	Pollution degree	For use in Pollution Degree 2 environment

DVI-D Input Interface



ELECTRIC SHOCK AND FIRE

When using the SG terminal to connect an external device to this product:

- Verify that a short-circuit loop is not created when you set up the system.
- Connect the SG terminal to remote equipment when the external device is not isolated. Connect the SG terminal to a known reliable ground connection to reduce the risk of damaging the circuit.

Failure to follow these instructions will result in death or serious injury.

DVI-D 24 Pin Socket Connector

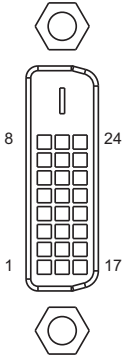
Product side	Pin No.	Signal name	Direction
	1	TMDS DATA 2-	Input
	2	TMDS DATA 2+	Input
	3	TMDS DATA 2 SHIELD (SG)	–
	4	NC	–
	5	NC	–
	6	DDC Clock	Input
	7	DDC Data	Input/Output
	8	NC	–
	9	TMDS DATA 1-	Input
	10	TMDS DATA 1+	Input
	11	TMDS DATA 1 SHIELD (SG)	–
	12	NC	–
	13	NC	–
	14	NC	–
	15	SHIELD (SG)	–
	16	Hot Plug Detect	Output
	17	TMDS DATA 0-	Input
	18	TMDS DATA 0+	Input
	19	TMDS DATA 0 SHIELD (SG)	–
	20	NC	–
	21	NC	–
	22	TMDS CLOCK SHIELD (SG)	–
	23	TMDS CLOCK+	Input
	24	TMDS CLOCK -	Input
Shell	FG	Functional Ground (Common with SG)	

Recommendations: DVI-D cable manufactured by Pro-face (FP-DV01-50 [5 m])

NOTE:

- For noise-free operation, use the recommended DVI-D cable.
- When you use a commercial-type cable, the maximum length is 5 m.

System Structure

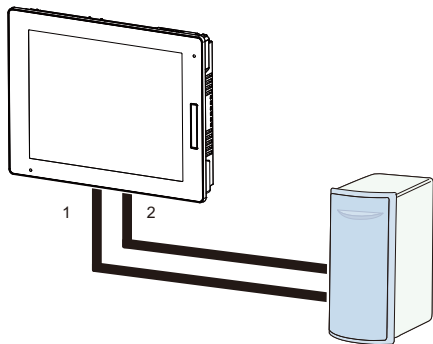

- 1 DVI-D cable: Connects DVI-D input interface and host (for image signal reception)
- 2 USB cable: Connects USB (Type B) interface and host (for touch-panel data transmission and front USB (Type A) interface activation)

Installation Requirements

This product is designed for use on a flat surface of Type 1, Type 4X (Indoor Use Only) or Type 13 Enclosure.

Mount this product in an enclosure that provides a clean, dry, robust and controlled environment (IP65F^{*1}, IP66F^{*1}, IP67F^{*1}, Type 1, Type 4X [Indoor Use Only], or Type 13 Enclosure).

When using a factory-installed front USB cover (without screw), the front surface is IP65F^{*1}, IP67F^{*1} or Type 1 Enclosure. When using a front USB cover (with screw^{*2}) manufactured by Pro-face (Model Number PFXZCDCVUS1), the front surface is IP66F^{*1}, IP67F^{*1}, Type 1, Type 4X (Indoor Use Only) or Type 13 Enclosure.

Display front surface		Enclosure front surface
Without screw	With screw	
IP65F, IP67F, Type 1	IP66F, IP67F, Type 1, Type 4X (Indoor Use Only), Type 13	IP65F, IP66F, IP67F, Type 1, Type 4X (Indoor Use Only), Type 13

Regardless of using a factory-installed front USB cover or a front USB cover with screw, when the cover is open, the front surface is Type 1 Enclosure.

Be aware of the following when building this product into an end-use product:

- The rear face of this product is not approved as an enclosure. When building this product into an end-use product, be sure to use an enclosure that satisfies standards as the end-use product's overall enclosure.
- This product must be used indoors only.
- Install and operate this product with its front panel facing outward.

*1 IP65F, IP66F, and IP67F are not part of the UL certification.

*2 The necessary torque is 0.5 N·m (4.4 lb-in).

Check that the installation wall or cabinet surface is flat, in good condition and has no jagged edges. Metal reinforcing strips may be attached to the inside of the wall, near the panel-cut, to increase its rigidity.

Decide on the thickness of the enclosure wall, based on the level of strength required: 1.6...5 mm (0.06...0.2 in). Even if the installation wall thickness is within the recommended range for the “Panel Cut Dimensions”, depending on wall’s material, size, and installation location of this product and other devices, the installation wall could warp. To prevent warping, the installation surface may need to be strengthened.

Be sure that the surrounding air temperature and the ambient humidity are within their designated ranges. Surrounding air temperature: 0 to 60 °C (32 to 140 °F) (see the Environment Specifications for this product); ambient humidity: 10 to 90% RH; wet bulb temperature: maximum 39 °C [102 °F]. When installing this product in a cabinet or enclosure, the surrounding air temperature is the cabinet’s or enclosure’s internal temperature.

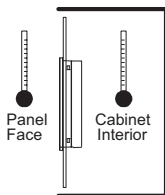

Be sure that heat from surrounding equipment does not cause this product to exceed its standard operating temperature.

When mounting this product vertically, ensure that the right side of this product faces up. In other words, the DC power connector should be at the top.

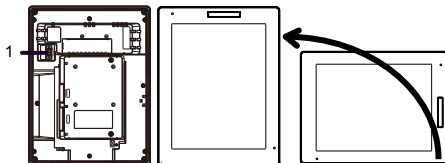

1 Power connector

When installing this product in a slanted position, the product face should not incline more than 30°.

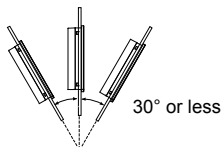

When installing this product in a slanted position with an incline more than 30°, the ambient temperature must not exceed 40 °C (104 °F). You may need to use forced air cooling (fan, A/C) to ensure the ambient operating temperature is 40 °C or less (104 °F or less).

For easier maintenance, operation and improved ventilation, install this product at least 100 mm (3.94 in) away from adjacent structures and other equipment as shown in the following illustration:

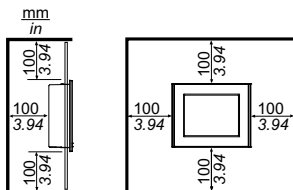

You can attach a commercial-type arm or wall-mount adapter using the arm mounting holes (VESA 75 mm specification) at the back of this product. Attach the four (4) M4 attachment screws (screw length: 10 mm [0.4 in]). The torque required for these screws is 0.7 to 0.8 N•m (6.2 to 7.1 lb-in).

Panel Cut Dimensions

Based on the panel cut dimensions, open a mount hole on the panel.

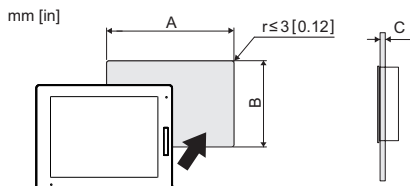

Display size	A	B	C
12.1-inch models	301.5 ⁺¹ ₋₀ mm (11.87 ^{+0.04} ₋₀ in)	227.5 ⁺¹ ₋₀ mm (8.96 ^{+0.04} ₋₀ in)	1.6... 5 mm (0.06... 0.2 in)
15-inch models	383.5 ⁺¹ ₋₀ mm (15.1 ^{+0.04} ₋₀ in)	282.5 ⁺¹ ₋₀ mm (11.12 ^{+0.04} ₋₀ in)	

Installation Procedure

Installing to the Panel



HAZARD OF ELECTRIC SHOCK, EXPLOSION OR ARC FLASH

- Remove all power from the device before removing any covers or elements of the system, and prior to installing or removing any accessories, hardware, or cables.
- Unplug the power cable from both this product and the power supply.
- Always use a properly rated voltage sensing device to confirm power is off.
- Replace and secure all covers or elements of the system before applying power to this product.

Failure to follow these instructions will result in death or serious injury.

NOTICE

EQUIPMENT DAMAGE

Keep this product stabilized in the panel-cut while you are installing or removing the screw fasteners.

Failure to follow these instructions can result in equipment damage.

Step	Action
1	Place this product on a clean and level surface with the screen facing down.
2	Check that the gasket of this product is seated securely into the gasket's groove, which runs around the perimeter of the display panel frame. NOTE: Always use the installation gasket, since it absorbs vibration in addition to repelling water. For the procedure on replacing the installation gasket, refer to the FP5000 Series User Manual.

- 3 Based on the panel cut dimensions of this product (see page 19), open a mount-hole on the panel and attach this product to the panel from the front side.

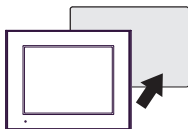

- 4 Confirm that the anti-drop lock on the top of this product is attached to the panel.

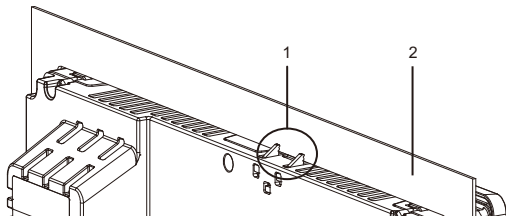

- 1 Anti-drop lock
2 Panel

- 5 Using a Phillips screwdriver, gradually tighten (turn clockwise) the screws for the fasteners (top, bottom, left, and right), alternating diagonally between screws until all are secure. Be sure that the L-shaped part of the installation fastener (2 in figure below) is completely vertical. The necessary torque is 0.5 N•m (4.4 lb-in).

NOTE:

- If this product is not mounted properly, it may fall.
- If the panel is thick (approx. 5 mm [0.2 in]), you may have trouble straightening the L-shaped part of the installation fastener. If this happens, push this product from the front as you tighten the screws.

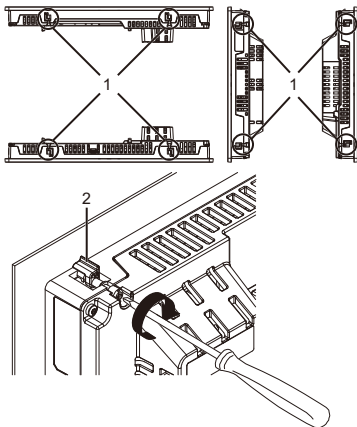

1 Installation fastener

2 L-shaped part of the installation fastener

Number of Installation Fasteners

	Top	Bottom	Right	Left
15-inch models	2	2	2	2
12-inch models	2	2	—	—

NOTICE**BROKEN ENCLOSURE**

Do not exert more than 0.5 N•m (4.4 lb-in) of torque when tightening the fastener's screws.

Failure to follow these instructions can result in equipment damage.

Removal Procedure

Removing from the Panel



HAZARD OF ELECTRIC SHOCK, EXPLOSION OR ARC FLASH

- Remove all power from the device before removing any covers or elements of the system, and prior to installing or removing any accessories, hardware, or cables.
- Unplug the power cable from both this product and the power supply.
- Always use a properly rated voltage sensing device to confirm power is off.
- Replace and secure all covers or elements of the system before applying power to this product.

Failure to follow these instructions will result in death or serious injury.

NOTICE

EQUIPMENT DAMAGE

- Keep this product stabilized in the panel-cut while you are installing or removing the screw fasteners.
- To avoid damage, remove this product while pushing the anti-drop lock or by making sure the lock does not touch the panel.

Failure to follow these instructions can result in equipment damage.

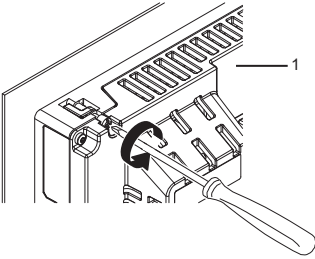
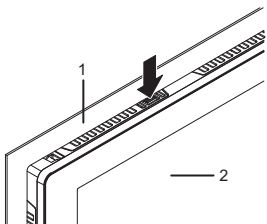
Step	Action
1	<p data-bbox="222 145 916 254">Using a Phillips screwdriver, gradually loosen (turn counter-clockwise) the screws for the fasteners (top, bottom, left, and right), alternating diagonally between screws until all screws are loose.</p>  <p data-bbox="222 604 347 633">1 Rear side</p> <p data-bbox="222 655 290 677">NOTE:</p> <ul data-bbox="222 691 927 822" style="list-style-type: none"> • For the number of installation fasteners on your model, refer to Number of Installation Fasteners in Step 5 of Installing to the Panel (see page 22). • If the panel is thick (approx. 5 mm [0.2 in]), you may have trouble straightening the L-shaped part of the installation fastener. If this happens, push this product from the front as you loosen the screws.
2	<p data-bbox="222 844 927 924">While pushing on the anti-drop lock on the top of this product with a tool such as a screwdriver, slowly remove this product from the panel.</p>  <p data-bbox="222 1244 352 1303">1 Panel 2 Front side</p>

CAUTION

RISK OF INJURY

Do not drop this product when you remove it from the panel.

- Hold this product in place after removing the fasteners.
- Use both hands.
- While pushing on the anti-drop lock, be careful not to hurt your fingers.

Failure to follow the instruction can result in injury or equipment damage.

Wiring



HAZARD OF ELECTRIC SHOCK, EXPLOSION OR ARC FLASH

- Remove all power from the device before removing any covers or elements of the system, and prior to installing or removing any accessories, hardware, or cables.
- Remove power before wiring this product's power terminals.
- Always use a properly rated voltage sensing device to confirm power is off.
- Replace and secure all covers or elements of the system before applying power to this product.
- This product uses only 12...24 Vdc power. Using any other level of power can damage both the power supply and this product.
- Since this product is not equipped with a power switch, be sure to connect a power switch to the power supply.
- Be sure to ground this product's FG terminal.

Failure to follow these instructions will result in death or serious injury.

NOTE:

- The SG (signal ground) and FG (functional ground) terminals are connected internally in this product.
- When the FG terminal is connected, be sure the wire is grounded. Not grounding this product can result in excessive electromagnetic interference (EMI).

DC Power Cord Preparation

- Make sure the ground wire is either the same or heavier gauge than the power wires.
- Do not use aluminum wires in the power supply cord.
- To prevent the possibility of a terminal short, use a pin terminal that has an insulating sleeve.
- If the ends of the individual wires are not twisted correctly, the wires may create a short circuit.
- The conductor type is solid or stranded wire.
- Use copper wire rated for 75 °C (167 °F).

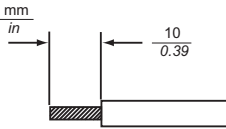
Power cord diameter	<ul style="list-style-type: none"> • 0.75...2.5 mm² • 18...13 AWG*¹
Conductor type	Solid or stranded wire
Conductor length	
Recommended driver* ²	SZS 0.6 x 3.5 (1205053)
Recommended pin terminals* ²	3201288 AI 0,75 - 10 GY 3200182 AI 1 - 10 RD 3200195 AI 1,5 - 10 BK 3202533 AI 2,5 - 10 BU
Recommended pin Terminal crimp tool* ²	CRIMPFOX6

*1 For UL compatibility, use AWG 14 or AWG 13.

*2 Items are made by Phoenix Contact.

Power Connector Specifications: Spring Clamp Terminal Blocks

This product comes with a right-angle-type power connector.

NOTE:

- You can also use a straight-type power connector.
- Right-angle type: PFXZCBCNDC2 manufactured by Pro-face
Straight type: PFXZCBCNDC1 manufactured by Pro-face

Right-angle type

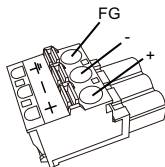

Straight type

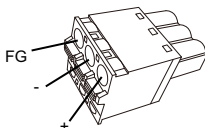

Connection	Wire
+	12...24 Vdc
-	0 Vdc
FG	Grounded terminal connected to the panel chassis

How to Connect the DC Power Cord

Step	Action
1	Confirm the power cord is not connected to the power supply.
2	Check the rated voltage, and remove the "DC24V" sticker on the DC power supply connector.
3	Connect each wire from the power cable to a pin terminal.
4	Push the opening button with a small and flat screwdriver to open the desired pin hole.
5	Insert each power cord wire into its corresponding holder. Release the opening button to clamp the wire in place. <div style="text-align: center; margin: 10px 0;"> <p>DC Power Cord</p> <p>Opening Button</p> <p>+ (12...24 Vdc)</p> <p>G (0 Vdc)</p> <p>+ FG</p> </div> <p>When using stranded wire, do not short with neighboring wires.</p>
6	After inserting all three power cord wires, insert the DC power supply connector into the power connector on this product.

NOTE: Do not solder the wire directly to the power crimp pin.

Wiring Precautions

Excessive stress on the power connection or attempting to install this product with the power cables connected may disconnect or cause damage to the power connections. This can cause short circuits, fire, or unintended equipment operation.

WARNING

SHORT CIRCUIT, FIRE, OR UNINTENDED EQUIPMENT OPERATION

Avoid excessive force on the power cable to prevent accidental disconnection

- Securely attach power cables to an installation panel or cabinet.
- Use the necessary torque to tighten this product terminal block screws.
- Install and fasten this product on installation panel or cabinet prior to connecting power supply and communication lines.

Failure to follow these instructions can result in death, serious injury, or equipment damage.

Improving Noise/Surge Resistance

- This product's power supply cord should not be bundled with or kept close to main circuit lines (high voltage, high current), power lines, or input/output lines, and their various systems should be kept separate. When power lines cannot be wired via a separate system, use shielded cables for input/output lines.
- Make the power cord as short as possible, and be sure to twist the ends of the wires together (i.e. twisted pair cabling) from close to the power supply unit.
- If there is an excess amount of noise on the power supply line, connect a noise reducing transistor before turning on the power.
- Connect a lightning surge absorber to handle power surges.
- To increase noise resistance, attach a ferrite core to the power cable.

Power Supply Connections

- Branch circuit protective device shall be used for rating 20 A for 12 to 24 Vdc input device for this product.
- You must use DC input with an isolating source for this product.
- The following shows a surge protection device connection:

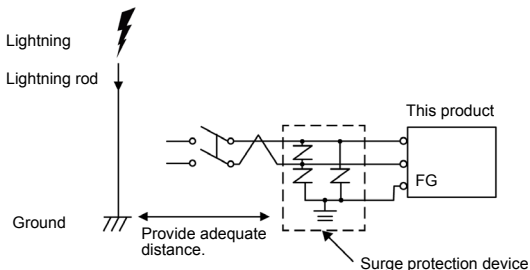

Attach a surge protection device to prevent damage to this product as a result of a lightning-induced power surge from a large electromagnetic field generated from a direct lightning strike. We also strongly recommend to connect the crossover grounding wire of this product to a position close to the ground terminal of the surge protection device.

It is expected that there will be an effect on this product due to fluctuations in grounding potential when there is a large surge flow of electrical energy to the lightning rod ground at the time of a lightning strike. Provide adequate distance between the lightning rod grounding point and the surge protection device grounding point.

Grounding

- Check that the grounding resistance is $100\ \Omega$ or less*1.
- The FG wire should have a cross sectional area greater than $2\ \text{mm}^2$ (AWG14)*1. Create the connection point as close to this product as possible, and make the wire as short as possible. When using a long grounding wire, replace the thin wire with a thicker wire, and place it in a duct.

*1 Observe local codes and standards.

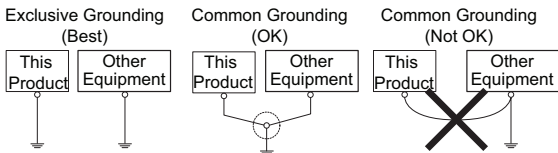

Short Circuit Prevention

- The SG (signal ground) and FG (functional ground) terminals are connected internally in this product. When connecting the SG line to another device, be sure that no shorting loops are formed.

USB Clamp

When using a USB device, attach a USB clamp to the USB interface to prevent the USB cable from being disconnected.

DANGER

POTENTIAL FOR EXPLOSION

- Verify that the power, input and output (I/O) wiring are in accordance with Class I, Division 2 wiring methods.
- Substitution of any component may impair suitability for Class I, Division 2.
- Do not disconnect equipment while the circuit is live or unless the area is known to be free of ignitable concentrations.
- Remove power before attaching or detaching any connectors to or from this product.
- Ensure that power, communication, and accessory connections do not place excessive stress on the ports. Consider the vibration in the environment when making this determination.
- Securely attach power, communication, and external accessory cables to the panel or cabinet.
- Use either a Pro-face manufactured USB cable or a commercial-type USB cable.
- Use only non-incendive USB configurations.
- Suitable for use in Class I, Division 2, Groups A, B, C, D Hazardous Locations.
- Confirm that the USB cable has been attached with the USB clamp before using the USB interface.

Failure to follow these instructions will result in death or serious injury.

Attaching USB Clamp (Type B)

NOTE: Watch your fingers. The edge of the clip is sharp.

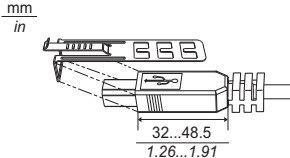
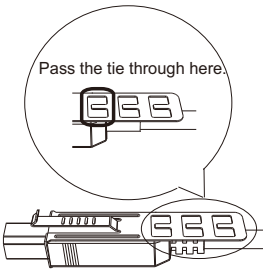
Step	Action
1	<p>Mount the clip to the USB mark  connector shell so that it overlaps. The clip matches the 32 to 48.5 mm (1.26 to 1.91 in) length of the USB connector.</p> 
2	<p>Align the clip and the USB cable connector shell. Adjust the position of the holes where the clip is attached. To ensure stability, select the clip-hole position that is closest to the base of the connector shell.</p> 

USB Clamp

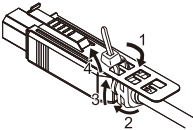
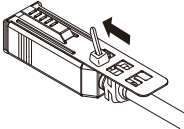
3	<p>As shown, pass the tie through the clip hole. Next, turn the tie and pass it through the head so that the USB cable can pass through the center of the tie loop. The clip is now attached to the USB cable.</p>  <p>NOTE:</p> <ul style="list-style-type: none"> • Check the direction of the head beforehand. Make sure the USB cable is through the center of the tie loop and that the tie can pass through the head. • If the provided ties are lost, you can substitute them with Pro-face manufactured ties (PFXZFP5000USCLB1) or commercially available ties of 4.8 mm (0.19 in) width and 1.3 mm (0.05 in) thickness.
4	<p>While pressing the grip on the clip, insert the cable from Step 3 all the way into the USB host interface. Make sure that the clip tab is secured to the USB cable attached to this product.</p> 

Removing USB Clamp (Type B)

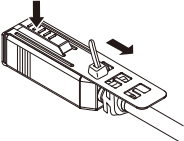
Step	Action
1	<p>Remove the USB cable while pushing the grip section of the clip.</p> 

Front USB Cover

When using a factory-installed front USB cover (without screw), the front surface is IP65F^{*1}, IP67F^{*1} or Type 1 Enclosure. When using a front USB cover for (with screw^{*2}) manufactured by Pro-face (Model Number PFXZCDCVUS1), the front surface is IP66F^{*1}, IP67F^{*1}, Type 1, Type 4X (Indoor Use Only) or Type 13 Enclosure.

Regardless of using a factory-installed front USB cover or a front USB cover with screw, when the cover is open, the front surface is Type 1 Enclosure.

CAUTION

RISK OF INJURY

When opening the front USB cover, be careful not to injure your fingers.

Failure to follow these instructions can result in injury or equipment damage.

*1 IP65F, IP66F, and IP67F are not part of the UL certification.

*2 The necessary torque is 0.5 N•m (4.4 lb-in)

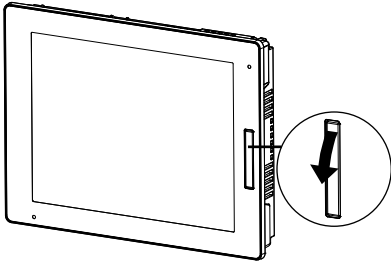
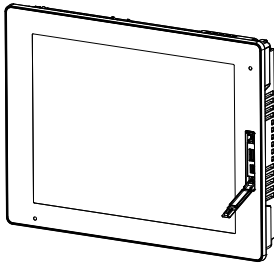
Step	Action
1	<p data-bbox="222 182 916 232">Place your finger or a tool such as a screwdriver in the gap on the top of the front USB cover and pull down as illustrated.</p>  <p data-bbox="222 647 290 669">NOTE:</p> <ul data-bbox="222 677 916 764" style="list-style-type: none"><li data-bbox="222 677 916 735">• When using the Pro-face manufactured front USB cover (PFXZCDCVUS1), loosen the top screw using a Phillips screwdriver.<li data-bbox="222 735 916 764">• The necessary torque is 0.5 N•m (4.4 lb-in).
2	<p data-bbox="222 778 916 829">The USB interface can be seen once you pull down the front USB cover.</p> 

NOTICE**BROKEN ENCLOSURE**

Do not exert more than 0.5 N·m (4.4 lb-in) of torque when tightening the screw.

Failure to follow these instructions can result in equipment damage.

Front USB Port

USB Connections

Non-incendive field wiring apparatus (keyboards, mouse) are permitted for use on the front USB port (Type A) of associated field wiring non-incendive apparatus (this product).

In addition to being non-incendive, any equipment connected to the front USB ports must satisfy the following criteria.

The following figures show the USB cable wiring:

<Type A>

Associated non-incendive
field wiring apparatus

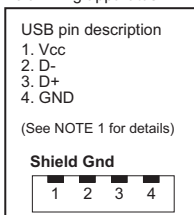

Class I, Division 2, Groups A, B,
C, D, or non-hazardous location

Non-incendive field
wiring apparatus

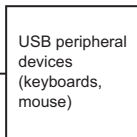

Class I, Division 2
Groups A, B, C, D

USB cable

Circuit parameters	Front USB (Type A)
Open-circuit voltage = V_{oc}	5.25 V
Short-circuit current = I_{sc}	1300 mA
Associated capacitance = C_a	265 μ F
Associated inductance = L_a	16 μ H

<mini-B>

NOTE: The front USB port (mini-B) cannot be used.

Non-incendive
field wiring apparatus

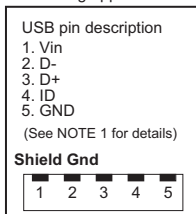

Class I, Division 2
Groups A, B, C, D

Associated non-incendive
field wiring apparatus

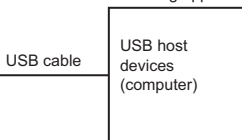

Class I, Division 2
Groups A, B, C, D
or non-hazardous location

Circuit parameters	Front USB (mini-B)
Maximum input voltage = V_{\max}	5.25 V
Maximum load current = I_{\max}	0.1 mA
Internal capacitance = C_i	0.24 μ F
Internal inductance = L_i	16 μ H

NOTE:

- The above table lists the non-incendive circuit parameters. The Entity Concept allows interconnection of non-incendive apparatus with associated apparatus – not specifically examined combinations – as a system when the approved values of V_{oc} (or U_o) and I_{sc} (or I_o) for the associated apparatus are less than or equal to V_{\max} (U_i) and I_{\max} (I_i) for the non-incendive apparatus, and the approved values of C_a (C_o) and L_a (L_o) for the associated apparatus are greater than or equal to $C_i + C_{\text{cable}}$ and $L_i + L_{\text{cable}}$, respectively, for the non-incendive field wiring apparatus.
- Associated non-incendive field wiring apparatus and non-incendive field wiring apparatus shall satisfy the following:

Associated non-incendive field wiring apparatus	-	Non-incendive field wiring apparatus
V_{oc}	\leq	V_{\max}
I_{sc}	\leq	I_{\max}
C_a	\geq	$C_i + C_{\text{cable}}$
L_a	\geq	$L_i + L_{\text{cable}}$

Front USB Port

3. If the electrical parameters of the cable are unknown, the following values may be used:

$$C_{\text{cable}} = 196.85 \text{ pF/m (60 pF/ft)}$$

$$L_{\text{cable}} = 0.656 \text{ } \mu\text{H/m (0.20 } \mu\text{H/ft)}$$

4. Wiring methods must be in accordance with the electrical code of the country where it is used.

This product must be installed in an enclosure. If installed in a Class I, Division 2 Location, the enclosure must be capable of accepting one or more Division 2 wiring methods.

DANGER

POTENTIAL FOR EXPLOSION

- Verify that the power, input and output (I/O) wiring are in accordance with Class I, Division 2 wiring methods.
- Substitution of any component may impair suitability for Class I, Division 2.
- Do not disconnect equipment while the circuit is live or unless the area is known to be free of ignitable concentrations.
- Remove power before attaching or detaching any connectors to or from this product.
- Ensure that power, communication, and accessory connections do not place excessive stress on the ports. Consider the vibration in the environment when making this determination.
- Securely attach power, communication, and external accessory cables to the panel or cabinet.
- Use either a Pro-face manufactured USB cable or a commercial-type USB cable.
- Use only non-incendive USB configurations.
- The associated non-incendive field wiring apparatus shall not be connected in parallel unless approved by the associated non-incendive apparatus.
- This product is suitable for use and provides non-incendive field wiring to apparatus in Class I, Division 2, Groups A, B, C, D.

Failure to follow these instructions will result in death or serious injury.



Launcher

About the Launcher









The Launcher is a utility that displays icons to configure settings on this product with convenient touch operation.

NOTE: Before using the Launcher, you need to install the required drivers and utilities. You can download the drivers and utilities from our website at <http://www.pro-face.com/trans/en/manual/1001.html>. For more detailed information, refer to the FP5000 Series User Manual.

How to Display the Launcher



Step	Action
1	<p data-bbox="225 193 901 244">On this product's screen, press and hold the locations below in the order indicated within 5 seconds.</p> 
2	<p data-bbox="225 633 515 659">The Launcher is displayed.</p>  <p data-bbox="225 1027 880 1106">NOTE: If multiple displays are connected to the host, the Launcher is displayed on the primary display (main display) by default in the factory setting.</p>

Icons

Display settings		Brightness	Sets the backlight brightness. You can select Manual or Auto . When Auto is selected, a brightness sensor automatically adjusts the brightness.
		Buzzer	Sets the sound on/off when starting the Launcher and performing touch operations.
		Front USB	Enables/disables the front USB port.
		T/P Calibration	Calibrates the touch coordinates.
		Launcher Set	Sets the display parameters so that the screen can be adjusted through the Launcher (see page 46).
PC settings		Display	Adjusts the contrast and black level of the display. This is a standard feature of Windows®.
		Power Option	Sets the amount of time before the display is turned off. This is a standard feature of Windows®.
		Tablet PC	Makes the host recognize that the display is touch-screen. This is a standard feature of Windows® 7 or later.
		Exit	Closes the Launcher.

Launcher Setting

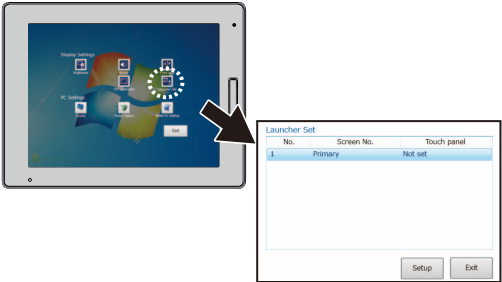
After you connect this product to the host, set the display parameters so that the screen can be adjusted through the Launcher.

Step	Action
1	<p>Touch or click the Launcher Set icon. In the Launcher Set dialog box, the FP5000 Series display connected to the host is displayed.</p> 
2	<p>Select any number. The status LED on the display for the selected number alternates between green and orange.</p>  <p>1 Status LED</p> <p>NOTE: If multiple FP5000 Series displays are connected, you cannot determine through the display which number corresponds to which display. Check the status LED.</p>

3

Select the **Screen No** (screen identification number) for the display where the status LED is alternating green and orange.

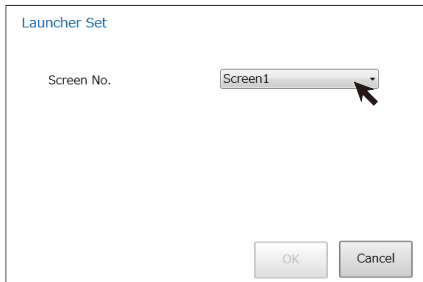

4

Following the dialog box instructions, touch the screen that has its status LED alternating between green and orange. After displaying the Launcher (see page 44), you can configure the settings for that screen.

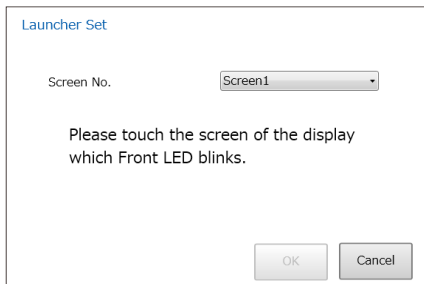

NOTE: If multiple displays are connected in extension mode (**Extend these displays** is selected), confirm that the above message appears on the display where the status LED is alternating green and orange, and touch this screen.

- 5 If multiple FP5000 Series displays are connected, repeat Steps 2 to 4 for each display as required.

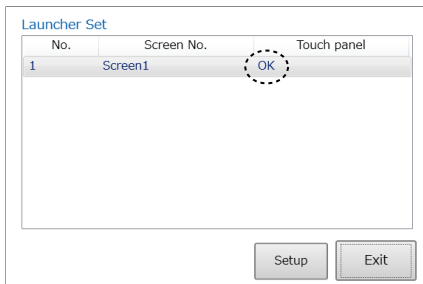

NOTE: When the FP5000 Series display is configured, OK appears in the **Touch panel** column.

NOTE: If you extend your desktop across multiple monitors connected to DVI-D ports, and you switch their DVI-D cables, touching one screen will operate the mouse pointer on the other screen. If you switch DVI-D cables, change the **Screen No** setting on the Launcher.

Standards

For information on certifications and standards, such as certified models and certificates, see the product markings or the following URL.
<http://www.pro-face.com/trans/en/manual/1002.html>

DANGER

POTENTIAL FOR EXPLOSION

- Suitable for use in Class I, Division 2, Groups A, B, C, and D Hazardous Locations.
- Substitution of any component may impair suitability for Class I, Division 2.
- Do not disconnect equipment while the circuit is live or unless power the area is known to be free of ignitable concentrations.
- Always confirm that this product is suitable for use in hazardous locations by checking that the ANSI/ISA 12.12.01 and CSA C22.2 N°213 certification appears on the product labeling.
- Do not attempt to install, operate, modify, maintain, service, or otherwise alter this product except as permitted in this manual. Unpermitted actions may impair the suitability of this product for Class I, Division 2 operation.
- To power on or power off this product installed in a Class I, Division 2 hazardous location, you must either:
 - Use a switch located outside the hazardous environment, or
 - Use a switch certified for Class I, Division 1 operation inside the hazardous area.
- Do not disconnect equipment unless power has been switched off or the area is known to be non-hazardous. This applies to all connections including power, ground, serial, parallel, and network connections.
- Never use unshielded / ungrounded cables in hazardous locations.
- When enclosed, keep enclosure doors and openings closed at all times to avoid the accumulation of foreign matter inside the workstation.

Failure to follow these instructions will result in death or serious injury.

The following message is for UL Hazardous Locations.

 **DANGER**

RISQUE D'EXPLOSION

- Le remplacement de n'importe quel composant peut nuire à la conformité à la Classe I, Division 2.
- Ne déconnectez pas l'équipement pendant que le circuit est sous tension ou s'il est connu que la zone est libre de concentrations inflammables.

Le non-respect de ces instructions entraînera la mort ou des blessures graves.

Inquiries

Do you have any questions about difficulty with your unit?

Please access our site any time that you need help with a solution.

<http://www.pro-face.com/trans/en/manual/1001.html>

Note

Please be aware that Digital Electronics Corporation shall not be held liable by the user for any damages, losses, or third party claims arising from the uses of this product.

中国 RoHS 相关资料

(本资料是中国 RoHS 的必备资料。)(This information is essential for China RoHS.)

部件名称 Part Name	有害物质 Hazardous Substances					
	铅 (Pb)	汞 (Hg)	镉 (Cd)	六价铬 (Cr (VI))	多溴联苯 (PBB)	多溴二苯醚 (PBDE)
金属部件 Metal parts	X	○	○	○	○	○
塑料部件 Plastic parts	○	○	○	○	○	○
电子件 Electronic	X	○	○	○	○	○
触点 Contacts	○	○	○	○	○	○
线缆和线缆附件 Cables & cabling accessories	○	○	○	○	○	○

本表格依据 SJ/T 11364 的规定编制。

○：表示该有害物质在该部件所有均质材料中的含量均在 GB/T 26572 规定的限量要求以下。

X：表示该有害物质至少在该部件的某一均质材料中的含量超出 GB/T 26572 规定的限量要求。

This table is made according to SJ/T 11364.

○：Indicates that the concentration of hazardous substance in all of the homogeneous materials for this part is below the limit as stipulated in GB/T 26572.

X：Indicates that concentration of hazardous substance in at least one of the homogeneous materials used for this part is above the limit as stipulated in GB/T 26572.